

CL50 Column Light

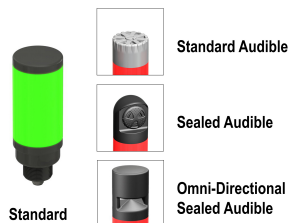

Datasheet

Multi-Color General Purpose or Audible Indicators



- Rugged, cost-effective, and easy-to-install multi-color indicators
- Illumination provides easy-to-see operator guidance and equipment status indication
- 1-, 2-, or 3-color models available
- Available in black or light gray housing
- Audible models available with standard, sealed, or omni-directional audible element
- Continuous, pulsed, and staccato tones available
- 18 V to 30 V dc operation
- Compact devices are completely self-contained, no controller needed
- No assembly required

Non-Audible Models

Models ¹	# of LED Colors	LED Colors ²			Connection ³	Inputs
		Color 1	Color 2	Color 3		
CL50GXXPQ	1	Green	-	-	Integral 4-pin M12/Euro-style quick disconnect	PNP
CL50GXXNQ		Green	-	-		NPN
CL50RXXPQ		-	Red	-		PNP
CL50RXNQ		-	Red	-		NPN
CL50GRXPQ	2	Green	Red	-		PNP
CL50GRXNQ		Green	Red	-		NPN
CL50GRYPQ	3	Green	Red	Yellow		PNP
CL50GRYNQ		Green	Red	Yellow		NPN

Audible Models

Standard Audible Models ¹	# of LED Colors	LED Colors ²			Connection ³	Inputs
		Color 1	Color 2	Color 3		
CL50GXXAPQ	1	Green	-	-	Integral 5-pin M12/Euro-style quick disconnect	PNP
CL50GXXANQ		Green	-	-		NPN
CL50RXAPQ		-	Red	-		PNP
CL50RXANQ		-	Red	-		NPN
CL50GRXPQ	2	Green	Red	-		PNP
CL50GRXANQ		Green	Red	-		NPN
CL50GRYAPQ	3	Green	Red	Yellow		PNP
CL50GRYANQ		Green	Red	Yellow		NPN

¹ Models with black housing are listed. For gray housing, add the suffix "C" at the end of the cabled model number or before the "Q" of quick disconnect model numbers. For example, CL50GXXAPC or CL50GXXAPCQ.

² Available colors include: Green (G), Red (R), Yellow (Y), Blue (B), and White (W). Contact Banner Engineering for other colors and color combinations.

³

- To order the 150 mm (6 in) PVC cable model with a M12/Euro-style quick disconnect, replace the suffix "Q" with "QP" in the model number. For example, CL50GXXAPQP.
- To order the 2 m (6.5 ft) PVC cable model, omit the suffix "Q" in the model number. For example, CL50GXXAP.
- Models with a quick disconnect require a mating cordset.



Sealed Audible Models ¹			# of LED Colors	LED Colors ²			Connection ³	Inputs
Continuous	Pulsed at 1.6 Hz	Staccato		Color 1	Color 2	Color 3		
CL50GXXALSPQ	CL50GXXALS3PQ	CL50GXXALS4PQ	1	Green	-	-	Integral 5-pin M12/Euro-style quick disconnect	PNP
CL50GXXALS3PQ	CL50GXXALS3NQ	CL50GXXALS4NQ		Green	-	-		NPN
CL50RXALSPQ	CL50RXALS3PQ	CL50RXALS4PQ		-	Red	-		PNP
CL50RXALS3PQ	CL50RXALS3NQ	CL50RXALS4NQ		-	Red	-		NPN
CL50GRXALSPQ	CL50GRXALS3PQ	CL50GRXALS4PQ	2	Green	Red	-		PNP
CL50GRXALS3PQ	CL50GRXALS3NQ	CL50GRXALS4NQ		Green	Red	-		NPN
CL50GRYALSPQ	CL50GRYALS3PQ	CL50GRYALS4PQ	3	Green	Red	Yellow		PNP
CL50GRYALS3PQ	CL50GRYALS3NQ	CL50GRYALS4NQ		Green	Red	Yellow		NPN

Omni-Directional Sealed Audible Models ¹			# of LED Colors	LED Colors ²			Connection ³	Inputs
Continuous	Pulsed at 1.6 Hz	Staccato		Color 1	Color 2	Color 3		
CL50GXXAOSPQ	CL50GXXAOS3PQ	CL50GXXAOS4PQ	1	Green	-	-	Integral 5-pin M12/Euro-style quick disconnect	PNP
CL50GXXAOS3PQ	CL50GXXAOS3NQ	CL50GXXAOS4NQ		Green	-	-		NPN
CL50RXAOSPQ	CL50RXAOS3PQ	CL50RXAOS4PQ		-	Red	-		PNP
CL50RXAOS3PQ	CL50RXAOS3NQ	CL50RXAOS4NQ		-	Red	-		NPN
CL50GRXAOSPQ	CL50GRXAOS3PQ	CL50GRXAOS4PQ	2	Green	Red	-		PNP
CL50GRXAOS3PQ	CL50GRXAOS3NQ	CL50GRXAOS4NQ		Green	Red	-		NPN
CL50GRYAOSPQ	CL50GRYAOS3PQ	CL50GRYAOS4PQ	3	Green	Red	Yellow		PNP
CL50GRYAOS3PQ	CL50GRYAOS3NQ	CL50GRYAOS4NQ		Green	Red	Yellow		NPN

Omni-Directional Sealed Audible Models with Intensity Adjustment ¹			# of LED Colors	LED Colors ²			Connection ³	Inputs
Continuous	Pulsed at 1.6 Hz	Staccato		Color 1	Color 2	Color 3		
CL50GXXAOSIPQ	CL50GXXAOS3IPQ	CL50GXXAOS4IPQ	1	Green	-	-	Integral 5-pin M12/Euro-style quick disconnect	PNP
CL50GXXAOS3IPQ	CL50GXXAOS3INQ	CL50GXXAOS4INQ		Green	-	-		NPN
CL50RXAOSIPQ	CL50RXAOS3IPQ	CL50RXAOS4IPQ		-	Red	-		PNP
CL50RXAOS3IPQ	CL50RXAOS3INQ	CL50RXAOS4INQ		-	Red	-		NPN
CL50GRXAOSIPQ	CL50GRXAOS3IPQ	CL50GRXAOS4IPQ	2	Green	Red	-		PNP
CL50GRXAOS3IPQ	CL50GRXAOS3INQ	CL50GRXAOS4INQ		Green	Red	-		NPN
CL50GRYAOSIPQ	CL50GRYAOS3IPQ	CL50GRYAOS4IPQ	3	Green	Red	Yellow		PNP
CL50GRYAOS3IPQ	CL50GRYAOS3INQ	CL50GRYAOS4INQ		Green	Red	Yellow		NPN

Wiring Diagrams — Non-Audible Models

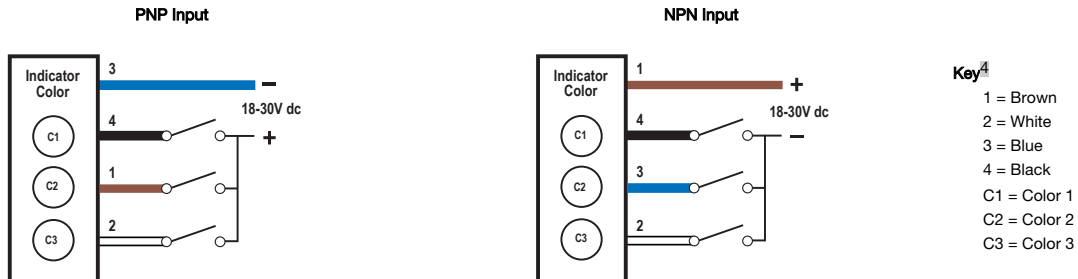

⁴ If there is an "X" in the model number, the corresponding wire will not be used.

Wiring Diagrams — Audible Models

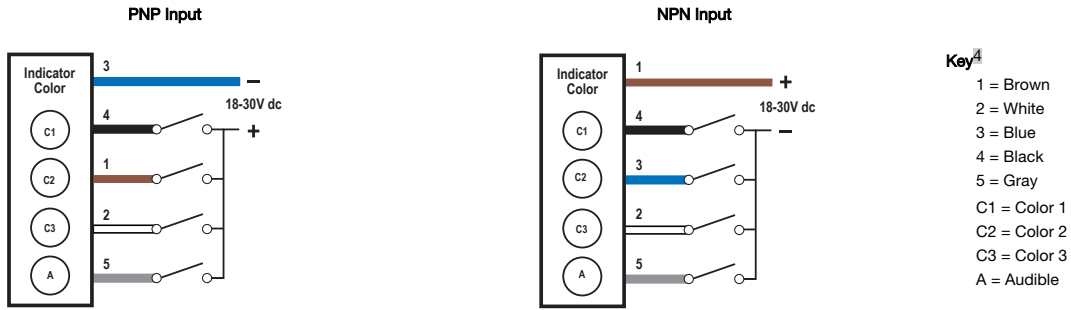

Functional Truth Table: PNP Models

LED Function	Pin 4 (Black Wire)	Pin 1 (Brown Wire)	Pin 2 (White Wire)	
Color 1 On	+V dc			Pin 3 (blue wire) connected to ground (-). Alarm models: Alarm function is independent of light functions.
Color 2 On		+V dc		
Color 3 On			+V dc	
Color 3 On (color 3 inhibits color 1)	+V dc		+V dc	
Color 2 On (color 2 inhibits color 1)	+V dc	+V dc		
Color 3 On (color 3 inhibits color 2)		+V dc	+V dc	
Color 3 On (color 3 inhibits colors 1 & 2)	+V dc	+V dc	+V dc	

Functional Truth Table: NPN Models

LED Function	Pin 4 (Black Wire)	Pin 3 (Blue Wire)	Pin 2 (White Wire)	
Color 1 On	-V dc			Pin 1 (brown wire) connected to +V dc. Alarm models: Alarm function is independent of light functions.
Color 2 On		-V dc		
Color 3 On			-V dc	
Color 3 On (color 3 inhibits color 1)	-V dc		-V dc	
Color 2 On (color 2 inhibits color 1)	-V dc	-V dc		
Color 3 On (color 3 inhibits color 2)		-V dc	-V dc	
Color 3 On (color 3 inhibits colors 1 & 2)	-V dc	-V dc	-V dc	

Specifications

Supply Voltage and Current

18 V dc to 30 V dc

Indicators—maximum current per LED color:

- 100 mA at 18 V dc
- 70 mA at 30 V dc

Standard Audible Alarm: 25 mA maximum current

Sealed Audible Alarm: 35 mA maximum current

Omni-Directional Sealed Audible Alarm: 45 mA maximum current

Supply Protection Circuitry

Protected against reverse polarity and transient voltages

Indicator Response Time

Indicator On/Off: 10 milliseconds maximum

Audible Alarm

Standard Audible Alarm: 2.7 KHz ± 500 Hz oscillation frequency; maximum intensity 92 db at 1 meter (3.3 ft) (typical)

Sealed Audible Alarm: 2.9 KHz ± 250 Hz oscillation frequency; maximum intensity 94 db at 1 meter (3.3 ft) (typical)

Omni-Directional Sealed Audible Alarm: 2.1 KHz ± 250 Hz oscillation frequency; maximum intensity 99 db at 1m (3.3 ft) (typical)

Omni-Directional Sealed Audible Alarm with Intensity Adjustment: 2.1 KHz ± 250 Hz oscillation frequency; maximum intensity 95 dB at 1m (3.3 ft) (typical)

Indicators

LEDs or audible are independently selected

Indicator Characteristics

Color	Dominant Wavelength (nm) or Color Temperature (CCT)	Lumen Output (Typical at 25 °C)
Green	525 nm	72
Red	625 nm	38
Yellow	590 nm	30
Blue	475 nm	28
White	5000 K	85

Audible Adjustment

Standard Audible Alarm: Unscrew the cover (up to 1.5 turns maximum) to adjust the audible intensity. Do not exceed 1.5 turns or the cover may detach during operation. For maximum intensity, rotate the center plug 180° counterclockwise to remove it.

Sealed Audible Alarm and Omni-Directional Sealed Audible Alarm with Intensity Adjustment: Rotate the front cover until the desired intensity is reached

Typical Reduction in Sound Intensity with Audible Adjustment (maximum to minimum):

- **Standard Audible:** 30 dB
- **Sealed Audible:** 20 dB
- **Omni-Directional Sealed Audible:** 12 dB

Construction

Bases and Covers: ABS
Light Segment: Polycarbonate

Vibration and Mechanical Shock

Meets IEC 60068-2-6 requirements (Vibration: 10 Hz to 55 Hz, 1.0 mm amplitude, 5 minutes sweep, 30 minutes dwell)
 Meets IEC 60068-2-27 requirements (Shock: 30G 11 ms duration, half sine wave)

Operating Conditions

Non-Audible: -40 °C to +50 °C (-40 °F to +122 °F)
Standard and Sealed Audible: -20 °C to +50 °C (-4 °F to +122 °F)
 95% at +50 °C maximum relative humidity (non-condensing)

Environmental Rating

NEMA/UL Type 13, 4X Indoor
Non-Audible and Sealed Audible: IEC IP67
Standard Audible: IEC IP50

Certifications



Connections

Integral 4-pin or 5-pin M12/Euro-style quick disconnect, 150 mm (6 in) PVC cable with a M12/Euro-style quick disconnect, or 2 m (6.5 ft) integral PVC cable, depending on model
 Models with a quick disconnect require a mating cordset

Required Overcurrent Protection



WARNING: Electrical connections must be made by qualified personnel in accordance with local and national electrical codes and regulations.

Overcurrent protection is required to be provided by end product application per the supplied table.
 Overcurrent protection may be provided with external fusing or via Current Limiting, Class 2 Power Supply.
 Supply wiring leads < 24 AWG shall not be spliced.
 For additional product support, go to www.bannerengineering.com.

Supply Wiring (AWG)	Required Overcurrent Protection (Amps)
20	5.0
22	3.0
24	2.0
26	1.0
28	0.8
30	0.5

Dimensions

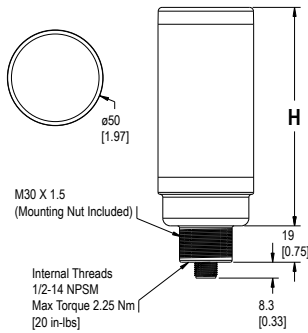

Column Light Height (H)	
Non-Audible	114.2mm (4.5 in)
Standard Audible*	145.3mm (5.7 in)
Sealed Audible	168.2mm (6.6 in)
Omni-Directional Sealed Audible	182.2mm (7.2 in)

*Column Light (H) with top unscrewed approximately 3.5 mm to allow sound to escape

All measurements are listed in millimeters [inches], unless noted otherwise.

Accessories

Cordsets

4-Pin Threaded M12/Euro-Style Cordsets				
Model	Length	Style	Dimensions	Pinout (Female)
MQDC-406	1.83 m (6 ft)	Straight		 1 = Brown 2 = White 3 = Blue 4 = Black
MQDC-415	4.57 m (15 ft)			
MQDC-430	9.14 m (30 ft)			
MQDC-450	15.2 m (50 ft)			
MQDC-406RA	1.83 m (6 ft)	Right-Angle		
MQDC-415RA	4.57 m (15 ft)			
MQDC-430RA	9.14 m (30 ft)			
MQDC-450RA	15.2 m (50 ft)			

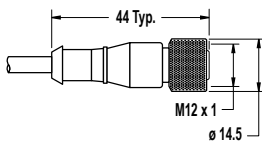
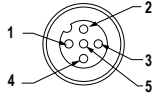
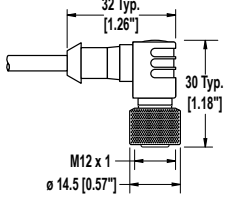
5-Pin Threaded M12/Euro-Style Cordsets—Single Ended				
Model	Length	Style	Dimensions	Pinout (Female)
MQDC1-501.5	0.50 m (1.5 ft)	Straight		 <p>1 = Brown 2 = White 3 = Blue 4 = Black 5 = Gray</p>
MQDC1-506	1.83 m (6 ft)			
MQDC1-515	4.57 m (15 ft)			
MQDC1-530	9.14 m (30 ft)	Right-Angle		
MQDC1-506RA	1.83 m (6 ft)			
MQDC1-515RA	4.57 m (15 ft)			
MQDC1-530RA	9.14 m (30 ft)			

Mounting Brackets

SMB30A

- Right-angle bracket with curved slot for versatile orientation
- Clearance for M6 (1/4 in) hardware
- Mounting hole for 30 mm sensor
- 12-ga. stainless steel

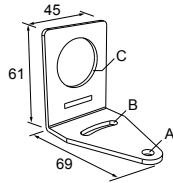

Hole center spacing: A to B=40
Hole size: A=ø 6.3, B= 27.1 x 6.3, C=ø 30.5

SMB30FA

- Swivel bracket with tilt and pan movement for precise adjustment
- Mounting hole for 30 mm sensor
- 12-ga. 304 stainless steel
- Easy sensor mounting to extrude rail T-slot
- Metric and inch size bolt available

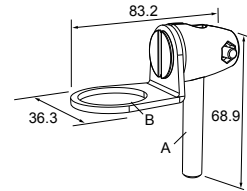

Bolt thread: SMB30FA, A= 3/8 - 16 x 2 in; SMB30FAM10, A= M10 - 1.5 x 50
Hole size: B= ø 30.1

SMB30MM

- 12-ga. stainless steel bracket with curved mounting slots for versatile orientation
- Clearance for M6 (1/4 in) hardware
- Mounting hole for 30 mm sensor

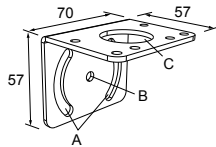

Hole center spacing: A = 51, A to B = 25.4
Hole size: A = 42.6 x 7, B = ø 6.4, C = ø 30.1

SMBAMS30P

- Flat SMBAMS series bracket
- 30 mm hole for mounting sensors
- Articulation slots for 90°+ rotation
- 12-ga. 300 series stainless steel

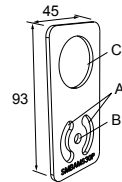

Hole center spacing: A=26.0, A to B=13.0
Hole size: A=26.8 x 7.0, B=ø 6.5, C=ø 31.0

SMBAMS30RA

- Right-angle SMBAMS series bracket
- 30 mm hole for mounting sensors
- Articulation slots for 90°+ rotation
- 12-ga. (2.6 mm) cold-rolled steel

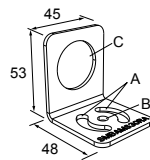

Hole center spacing: A=26.0, A to B=13.0
Hole size: A=26.8 x 7.0, B=ø 6.5, C=ø 31.0

SMB30SC

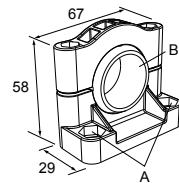

- Swivel bracket with 30 mm mounting hole for sensor
- Black reinforced thermoplastic polyester
- Stainless steel mounting and swivel locking hardware included





Hole center spacing: A=ø 50.8
Hole size: A=ø 7.0, B=ø 30.0

All measurements are listed in millimeters [inches], unless noted otherwise.

LMB Sealed Right-Angle Bracket

Model	Description	Construction	
LMB30RA	Direct-Mount Models: Bracket kit with base, 30 mm adapter, set screw, fasteners, O-rings, and gaskets.	Black polycarbonate	
LMB30RAC		Gray polycarbonate	
LMBE12RA	Pipe-Mount Models: Bracket kit with base, 1/2-14 pipe adapter, set screw, fasteners, O-rings, and gaskets. For use with stand-off pipe (listed and sold separately).	Black polycarbonate	
LMBE12RAC		Gray polycarbonate	

Elevated Mount System

Model	Features			Components												
SA-M30TE12 - Black Acetal	<ul style="list-style-type: none"> Streamlined black acetal or white UHMW stand-off pipe adapter/cover Connects between 30 mm light base and 1/2 in. NPSM/DN15 pipe Mounting hardware included 															
SA-M30TE12C - White UHMW																
<table border="1"> <thead> <tr> <th>Polished 304 Stainless Steel</th> <th>Black Anodized Aluminum</th> <th>Clear Anodized Aluminum</th> </tr> </thead> <tbody> <tr> <td>SOP-E12-150SS 150 mm (6 in) long</td> <td>SOP-E12-150A 150 mm (6 in) long</td> <td>SOP-E12-150AC 150 mm (6 in) long</td> </tr> <tr> <td>SOP-E12-300SS 300 mm (12 in) long</td> <td>SOP-E12-300A 300 mm (12 in) long</td> <td>SOP-E12-300AC 300 mm (12 in) long</td> </tr> <tr> <td>SOP-E12-900SS 900 mm (36 in) long</td> <td>SOP-E12-900A 900 mm (36 in) long</td> <td>SOP-E12-900AC 900 mm (36 in) long</td> </tr> </tbody> </table>	Polished 304 Stainless Steel	Black Anodized Aluminum	Clear Anodized Aluminum	SOP-E12-150SS 150 mm (6 in) long	SOP-E12-150A 150 mm (6 in) long	SOP-E12-150AC 150 mm (6 in) long	SOP-E12-300SS 300 mm (12 in) long	SOP-E12-300A 300 mm (12 in) long	SOP-E12-300AC 300 mm (12 in) long	SOP-E12-900SS 900 mm (36 in) long	SOP-E12-900A 900 mm (36 in) long	SOP-E12-900AC 900 mm (36 in) long	<ul style="list-style-type: none"> Elevated-use stand-off pipe (1/2 in. NPSM/DN15) Polished 304 stainless steel, black anodized aluminum, or clear anodized aluminum surface 1/2 in. NPT thread at both ends Compatible with most industrial environments 			
Polished 304 Stainless Steel	Black Anodized Aluminum	Clear Anodized Aluminum														
SOP-E12-150SS 150 mm (6 in) long	SOP-E12-150A 150 mm (6 in) long	SOP-E12-150AC 150 mm (6 in) long														
SOP-E12-300SS 300 mm (12 in) long	SOP-E12-300A 300 mm (12 in) long	SOP-E12-300AC 300 mm (12 in) long														
SOP-E12-900SS 900 mm (36 in) long	SOP-E12-900A 900 mm (36 in) long	SOP-E12-900AC 900 mm (36 in) long														
SA-E12M30 - Black Acetal	<ul style="list-style-type: none"> Streamlined black acetal or white UHMW mounting base adapter/cover Connects between 1/2 in. NPSM/DN15 pipe and 30 mm (1-3/16 in) drilled hole Mounting hardware included 															
SA-E12M30C - White UHMW																

Pipe Mounting Flange

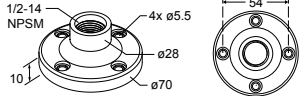
Pipe Mounting Flange			
Model	Features	Construction	
SA-F12	<ul style="list-style-type: none"> For use elevated stand-off pipes (1/2 in, NPSM/DN15) M5 mounting hardware and nitrile gasket included 	Die-cast zinc base with black paint	

Banner Engineering Corp. Limited Warranty

Banner Engineering Corp. warrants its products to be free from defects in material and workmanship for one year following the date of shipment. Banner Engineering Corp. will repair or replace, free of charge, any product of its manufacture which, at the time it is returned to the factory, is found to have been defective during the warranty period. This warranty does not cover damage or liability for misuse, abuse, or the improper application or installation of the Banner product.

THIS LIMITED WARRANTY IS EXCLUSIVE AND IN LIEU OF ALL OTHER WARRANTIES WHETHER EXPRESS OR IMPLIED (INCLUDING, WITHOUT LIMITATION, ANY WARRANTY OF MERCHANTABILITY OR FITNESS FOR A PARTICULAR PURPOSE), AND WHETHER ARISING UNDER COURSE OF PERFORMANCE, COURSE OF DEALING OR TRADE USAGE.

This Warranty is exclusive and limited to repair or, at the discretion of Banner Engineering Corp., replacement. **IN NO EVENT SHALL BANNER ENGINEERING CORP. BE LIABLE TO BUYER OR ANY OTHER PERSON OR ENTITY FOR ANY EXTRA COSTS, EXPENSES, LOSSES, LOSS OF PROFITS, OR ANY INCIDENTAL, CONSEQUENTIAL OR SPECIAL DAMAGES RESULTING FROM ANY PRODUCT DEFECT OR FROM THE USE OR INABILITY TO USE THE PRODUCT, WHETHER ARISING IN CONTRACT OR WARRANTY, STATUTE, TORT, STRICT LIABILITY, NEGLIGENCE, OR OTHERWISE.**

Banner Engineering Corp. reserves the right to change, modify or improve the design of the product without assuming any obligations or liabilities relating to any product previously manufactured by Banner Engineering Corp. Any misuse, abuse, or improper application or installation of this product or use of the product for personal protection applications when the product is identified as not intended for such purposes will void the product warranty. Any modifications to this product without prior express approval by Banner Engineering Corp will void the product warranties. All specifications published in this document are subject to change; Banner reserves the right to modify product specifications or update documentation at any time. Specifications and product information in English supersede that which is provided in any other language. For the most recent version of any documentation, refer to: www.bannerengineering.com.